

Figure 7. Rapid sampling apparatus.

the gas-driven pipet shown as Figure 7 was used to extend the range of available half-times. This apparatus consists of a reac-

tion chamber, A, connected by way of a 120° stopcock, B, to a pipet of about 5-ml capacity, C; the whole is enclosed in a glass jacket through which constant temperature fluid may be circulated *via* openings D. At the beginning of an experiment, the stopcock is placed so that none of its arms are connected. Acid solution is then introduced into A, and a much smaller amount of substrate solution is placed in the hypodermic syringe, E, which extends into the apparatus through a serum-cap stopper. A supply of nitrogen or some other inert gas at a few pounds per square inch above atmospheric pressure is then connected to openings F and F'. When the acid solution has had sufficient time to come to thermal equilibrium with the water jacket, the reaction is begun by depressing the syringe plunger sharply and shaking the whole apparatus vigorously. Samples are removed by turning the stopcock to connect the reaction chamber to the pipet, allowing the reaction mixture to be driven in to fill the pipet, closing the stopcock, removing excess solution from the pipet tip G, and then expelling the sample into quenching solution through use of gas pressure at F'. Sampling times were noted by a second person, but this could also have been done by the operator speaking into a tape recorder and then timing the record by playing it back. Control experiments showed that the volumes delivered were reproducible to $\pm 0.2\%$ (standard deviation). With some experience using this apparatus, it is possible to take the first sample 15–20 sec after depressing the syringe plunger, and then to remove additional aliquots at 8–10-sec intervals. When used on substrates whose specific activity is sufficient to give an initial sample with counting rate 10^3 times background (so that ten half-lives of reaction may be observed), this method makes accessible specific rates of exchange up to 10^{-1} sec^{-1} .

A Potential Surface for the Insertion of Singlet Methylene into a Carbon–Hydrogen Bond

Richard C. Dobson, David M. Hayes, and Roald Hoffmann*

Contribution from the Department of Chemistry, Cornell University, Ithaca, New York 14850. Received January 14, 1971

Abstract: The potential energy surface for the concerted insertion of singlet methylene into a C–H bond of methane to form ethane is studied by the extended Hückel method. The reaction path is shown in Figures 5, 6, and 7. The reaction begins by an abstraction-like electrophilic attack of a methylene with its empty p orbital impinging on a slightly nonlinear geometry on the H atom. In the intermediate stage of the reaction the H atom is transferred to the methylene while the C–C distance changes little. The reaction terminates in a collapse to the equilibrium ethane structure. The reaction path resembles qualitatively that suggested previously by Benson. There is no indication on our surface of a competing pathway involving true abstraction.

A ubiquitous reaction of singlet methylenes is their rapid and generally indiscriminate insertion into C–H bonds.¹ From the time of the discovery of this reaction by Doering and coworkers² there has existed the question whether the mechanism of the reaction is a direct concerted one (eq 1) or whether a two-step abstraction–recombination path (eq 2) is followed. It

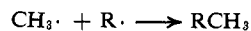
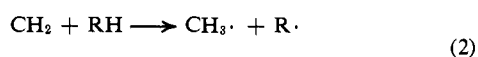
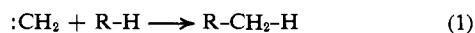

appears that both mechanisms are operative but that di-

rect insertion predominates. Thus Doering and Prinzbach³ found that photolysis of diazomethane in 2-methylpropene-*l*-¹⁴C leads mainly to ¹⁴C retention at the 1 position in the 2-methylbutene product. Retention of configuration results when the insertion occurs at an asymmetric carbon atom.^{4,5} Predominant one-step

(3) W. von E. Doering and H. Prinzbach, *Tetrahedron*, **6**, 24 (1959).

(4) (a) W. von E. Doering and L. E. Helgen, private communication; L. E. Helgen, Ph.D. Dissertation, Yale University, 1965; (b) L. Friedman and H. Shechter, *J. Amer. Chem. Soc.*, **83**, 3159 (1969); see also A. C. Cope, G. A. Berchtold, P. E. Peterson, and S. M. Sharman, *ibid.*, **82**, 6370 (1960); (c) W. Kirmse and M. Buschhoff, *Chem. Ber.*, **102**, 1098 (1969); (d) J. A. Landgrebe and R. D. Mathis, *J. Amer. Chem. Soc.*, **88**, 3545 (1966); (e) an exception to this conclusion is the reported finding of an insertion occurring with inversion by V. Franzen and R. Edens, *Justus Liebigs Ann. Chem.*, **729**, 33 (1969).

(5) J. A. Bell and G. B. Kistiakowsky, *J. Amer. Chem. Soc.*, **84**, 3417 (1962). Previous studies of this reaction may be found in C. Rosenblum, *ibid.*, **60**, 2819 (1938); M. Vanpee and F. Grard, *Bull. Soc. Chim. Belg.*, **60**, 208 (1951); J. Chanmugam and M. Burton, *J. Amer. Chem. Soc.*, **78**, 509 (1956). For related studies see H. M. Frey and G. B. Kistiakowsky, *ibid.*, **79**, 6373 (1957); H. M. Frey, *Proc. Chem. Soc.*, 318 (1959); C. H. Bamford, J. E. Casson, and A. N. Hughes, *Proc. Roy. Soc., Ser. A*, **306**, 135 (1968); W. Braun, A. M. Bass, and M. Pilling, *J. Chem. Phys.*, **52**, 5131 (1970).

(1) See reviews by W. Kirmse, "Carbene Chemistry," Academic Press, New York, N. Y., 1964; H. M. Frey, *Progr. React. Kinet.*, **2**, 131 (1964); J. A. Bell, *Progr. Phys. Org. Chem.*, **2**, 1 (1964).

(2) W. von E. Doering, R. G. Buttery, R. G. Laughlin, and N. Chaudhuri, *J. Amer. Chem. Soc.*, **78**, 3224 (1956); W. von E. Doering and L. H. Knox, *ibid.*, **83**, 1989 (1961). Antecedents for these reactions may be found in the work of H. Meerwein, H. Rathjen, and H. Werner, *Chem. Ber.*, **75**, 1610 (1942).

insertion is also indicated on the parent reaction of methylene with methane.⁵

This contribution is concerned with the potential surface for the insertion reaction, specifically with the geometries of the reaction path and the transition state. While the concerted nature of the reaction necessitates some sort of three-centered transition-state geometry, Benson⁶ has reasonably questioned the addition-like transition state formulation 1.^{3,7} Benson has suggested that the methylene initially attacks the H atom in an

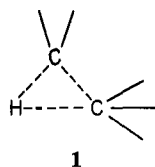

abstraction-like geometry, 2. The two alkyl radicals in close proximity complete the reaction by rotation in place and C-C bond formation.⁶ Our study was designed to examine this reaction path.

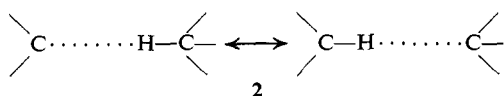

Calculations

The model reaction studied was (eq 3) the insertion of

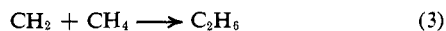

singlet methylene into a C-H bond of methane, to form ethane. The complete surface possesses 18 degrees of freedom. We have studied only six of these degrees of freedom, those shown in Figure 1. D is the vector connecting the methane carbon (C) to the methylene carbon (C') and serves as the reaction coordinate for the system. The methane is initially set with its carbon at the origin of the coordinate system. The methylene is constrained to make its approach with its hydrogens symmetrically placed on either side of the xz plane. This corresponds to placing the CH_2 group in a staggered conformation relative to the fixed CH_3 . Thus, for a given D , two angles, θ and $\epsilon\theta$ (see Figure 1), are sufficient to locate CH_2 relative to CH_3 . A second assumption is that the transfer of H from CH_4 to CH_2 will take place entirely in the xz plane.⁸ This constrains H_t , the transferred hydrogen, to two degrees of freedom, namely motion in the xz plane. All C-H distances except C- H_t were fixed at 1.09 Å, and the methylene HCH angle at tetrahedral. Since methyl radical is planar, and we wanted to examine methyl-like geometries along the reaction path, our sixth degree of freedom was a flattening of the CH_3 pyramid of methane, indicated by the angle α in Figure 1.⁹

The computational procedure was the extended Hückel method,¹⁰ a semiempirical molecular orbital

(6) S. W. Benson, *Advan. Photochem.*, **2**, 1 (1964); W. B. DeMore and S. W. Benson, *ibid.*, **2**, 219 (1964).

(7) P. S. Skell and R. C. Woodworth, *J. Amer. Chem. Soc.*, **78**, 4496 (1956).

(8) That this constraint is reasonable was tested by several calculations in which H_t was moved out-of-plane.

(9) In this flattening the CH_3 group maintains C_{3v} local symmetry, with its axis along z . Unsymmetrical deformations of the methyl group were also studied and found to be unfavorable.

(10) R. Hoffmann, *J. Chem. Phys.*, **39**, 1397 (1963), and subsequent papers. The H-1s exponent was taken as 1.3.

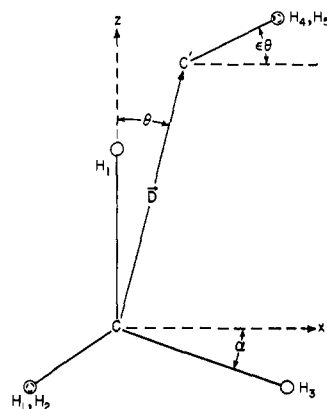

Figure 1. Coordinate system for $\text{CH}_2 + \text{CH}_4$ potential surface.

procedure with well-known quantitative deficiencies in the prediction of bond lengths and energies, but one known to model in a qualitative manner the essential features of molecular geometries and interaction. Optimization of the degrees of freedom was achieved by a direct search procedure due to Rosenbrock.¹¹ Finally, our calculation applies only to the $(\sigma)^2$ configuration of methylene, the prime contributor to the lowest singlet state of methylene.

The Potential Energy Surface

Given the specified degrees of freedom our potential surface should contain, for large D , at least two minima. The first of these should correspond to $\text{CH}_4 + \text{CH}_2$ and the second to $\text{CH}_3 + \text{CH}_3$. We began by constructing several grids at various fixed values of D . H_t was placed at about 200 different points in the xz plane and for each point those values of θ , $\epsilon\theta$, and α which minimize the energy were found. A typical grid of this type for $D = 4.0$ Å is shown in Figure 2. The variables here are the x and z coordinates of H_t . D is fixed, and for each point in this slice through the many-dimensional surface, θ , $\epsilon\theta$, and α are optimized. All energies are in electron volts relative to an infinitely separated CH_4 and CH_2 .

There is an obvious well-defined well with H_t along the z axis, clearly corresponding to H_t bonded to C, *i.e.*, " $\text{CH}_4 + \text{CH}_2$." The corresponding orientation of the methylene group will be shown below. The CH_3 group on this minimum is tetrahedral. There is another much broader valley in Figure 2, at $z \sim 4$ Å. In this minimum H_t is bonded to C' , *i.e.*, we have two methyl radicals. Correspondingly, the CH_3 group is planar as is $C'\text{H}_2\text{H}_t$. The broadness of the second valley is due to the large range of CH_2 orientations of similar energy when the CH_3 groups are far apart. Note that the calculation makes this " $\text{CH}_3 + \text{CH}_3$ " minimum some 7 kcal/mol more stable than " $\text{CH}_4 + \text{CH}_2$." Using tabulated heats of formation,¹² one calculates $\Delta H^\circ = +2$ kcal/mol for $\text{CH}_2 + \text{CH}_4 \rightarrow \text{CH}_3 + \text{CH}_3$, where the methylene is in its triplet ground state. For singlet methylene, the reaction we are calculating, the reaction would be more exothermic by an unknown amount corresponding to the singlet-triplet energy

(11) H. H. Rosenbrock, *Comp. J.*, **3**, 175 (1960), as adapted by K. D. Gibson.

(12) S. W. Benson, "Thermochemical Kinetics," Wiley, New York, N. Y., 1968, pp 200 and 204.

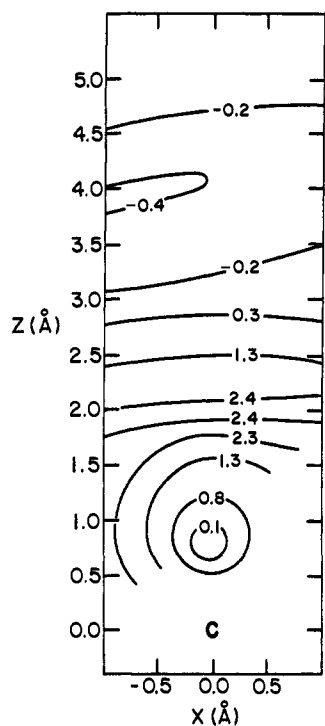

Figure 2. Cross section of the $\text{CH}_2 + \text{CH}_4$ potential surface at $D = 4.0 \text{ \AA}$. The fixed carbon atom is at lower center. The hydrogens attached to this carbon are not shown since their position is a function of the location of H_t . Similarly, the methylene location, optimized for each position of H_t , is not shown.

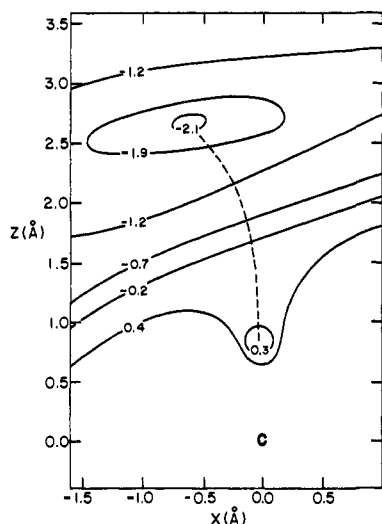

Figure 3. Cross section of the $\text{CH}_2 + \text{CH}_4$ potential surface at $D = 2.5 \text{ \AA}$. See caption to Figure 2 and text for convention.

difference.¹³ The calculated relative stability of $\text{CH}_4 + \text{CH}_2$ vs. $\text{CH}_3 + \text{CH}_3$ is therefore not in gross error.

Contour maps similar to Figure 2 were constructed for $D = 3.00, 2.50, 2.45, 2.00,$ and 1.50 \AA . At $D = 3.00$ the minimum corresponding to " $\text{CH}_4 + \text{CH}_2$ " remains essentially unchanged, while the well for " $\text{CH}_3 + \text{CH}_3$ " has become more localized and deeper. The barrier between the wells decreases from 2.5 eV at $D =$

(13) Most recently this difference has been set at 1–2 kcal/mol: R. W. Carr, Jr., T. W. Eder, and M. G. Topor, *J. Chem. Phys.*, **53**, 4761 (1970). Theoretical estimates are generally much higher: J. M. Fisher and S. F. Boys, *Rev. Mod. Phys.*, **26**, 716 (1957); J. F. Harrison and L. C. Allen, *J. Amer. Chem. Soc.*, **91**, 807 (1969), and references therein.

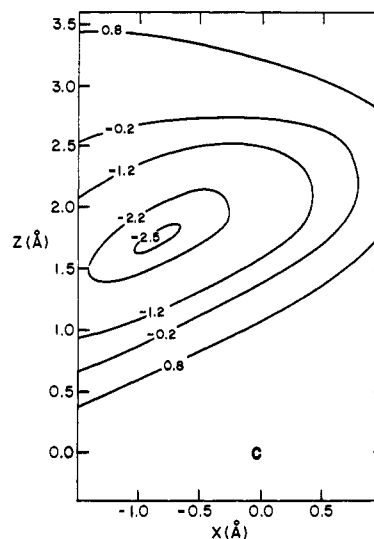

Figure 4. Cross section of the $\text{CH}_2 + \text{CH}_4$ potential surface at $D = 1.5 \text{ \AA}$. See caption to Figure 2 and text for convention.

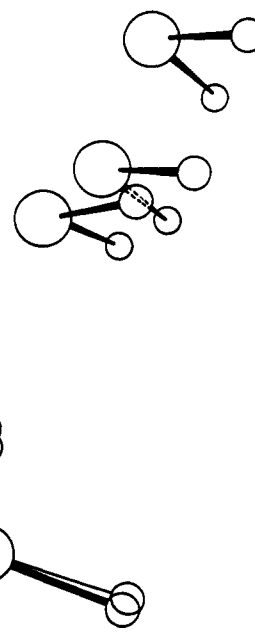

Figure 5. Superimposed views of the initial stage of the reaction path, $D = 4.0, 3.0,$ and 2.5 \AA . These are views, not projections, from a vantage point along the $-y$ axis.

4 \AA to 0.8 eV at $D = 3 \text{ \AA}$. Figure 3 shows the contour map at $D = 2.5 \text{ \AA}$. At this CC distance there are still two minima, but now the " $\text{CH}_3 + \text{CH}_3$ " well is much deeper, and the " $\text{CH}_4 + \text{CH}_2$ " well nearly washed out. Indeed at $2.45 > D > 2.40 \text{ \AA}$ this minimum disappears, to be replaced at shorter D with a single minimum corresponding to the H_t position in the product ethane. This is shown in Figure 4 for $D = 1.50 \text{ \AA}$.

The Reaction Path

We can now describe the reaction path for this reaction. The distant approach, $D > 2.5 \text{ \AA}$, corresponds to the geometries of the " $\text{CH}_4 + \text{CH}_2$ " wells. This is shown in a series of superimposed snapshots in Figure 5. In this region H_t does not move much at all,¹⁴ and

(14) The C– H_t bond length in this minimum is calculated to be too short—0.8 Å. This is a typical example of the deficiencies of the extended Hückel procedure.

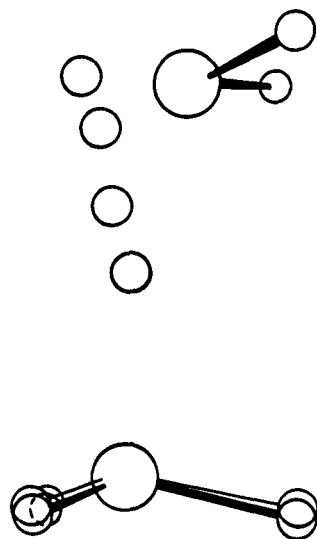
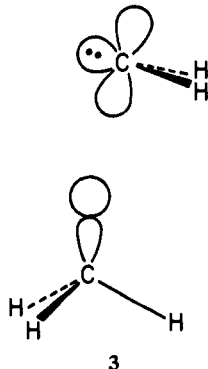

Figure 6. Superimposed views of the hydrogen-transfer stage of the reaction. D is fixed at 2.5 Å. These are views, not projections, from a vantage point along the $-y$ axis.

the geometry of the CH_3 group remains tetrahedral. The methylene approach is abstraction-like, confirming the suggestion of Benson.⁷ That a more triangular approach is not favored was checked specifically by starting our optimization search in such geometries. The methylene always moved to the positions shown in Figure 5.¹⁵

Note that the methylene orientation is such that it "leads" with its unoccupied electrophilic p orbital, **3**. This is not unexpected in view of the similar preference



expressed in the methylene addition to ethylene.¹⁶

In the next stage of the reaction, D ceases to be a good reaction coordinate. This is the hydrogen-transfer stage, $2.40 < D < 2.50$ Å. As may be seen from Figure 3 the " $\text{CH}_4 + \text{CH}_2$ " minimum is fading away in this region. While D remains approximately constant, a great gain in energy is achieved by moving H_t over to the methylene group. The optimum H_t path is approximated by the dashed line connecting the minima in Figure 3. A series of superimposed snapshots illustrating this stage of the reaction is given in Figure 6. Note the flattening of the CH_3 group as H_t is transferred to $\text{C}'\text{H}_2$.

(15) At large D we observed another local minimum in which the methylene is essentially displaced sideways to the $-x$ side. This minimum, also abstraction-like, was at somewhat higher energy than the geometry shown in Figure 5. At $D \leq 2.75$ Å this subsidiary valley merged with the global minimum.

(16) R. Hoffmann, *J. Amer. Chem. Soc.*, **90**, 1475 (1968); R. Hoffmann, D. M. Hayes, and P. S. Skell, to be published.

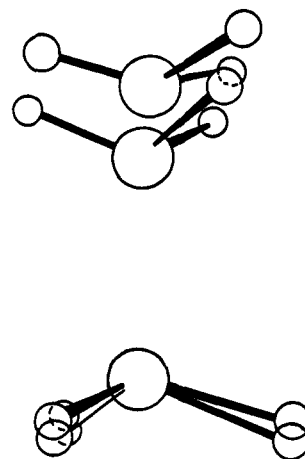

Figure 7. Superimposed views of the last stage of the reaction, $D = 2.0$ and 1.5 Å.

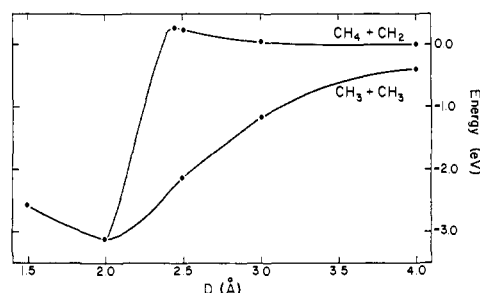

Figure 8. Computed energy along the insertion reaction path, compared to the methyl radical recombination.

The last stage of the reaction is the collapse to ethane, accompanied by repyramidalization of the two methyl groups. This is illustrated in Figure 7.

Insertion vs. Abstraction

The reaction path shown in Figures 5, 6, and 7 supports qualitatively the suggestion of Benson⁶ of an abstraction-like attack. The transition state for the reaction occurs in our calculation roughly in the first snapshot of Figure 6. C-H-C are not far from collinear, H_t has just begun to move, and CH_3 flattens a little. The calculated activation energy for the reaction is 0.3 eV or about 7 kcal/mol. This is an upper limit, bound to decrease when further degrees of freedom are allowed to the reaction path. The activation energy for the insertion reaction is not known,^{1,5} but it cannot exceed 5 kcal/mol.

The recombination of two methyl radicals to give ethane is known to be an extremely efficient process.⁶ We computed a potential energy surface for two methyl radicals dimerizing, optimizing pyramidalization at each stage. The resultant potential energy curve, which shows no activation barrier for the process, is compared in Figure 8 to the energy calculated for the insertion path of Figures 5, 6, and 7. Since the $\text{CH}_3 + \text{CH}_3$ recombination curve is always at lower energy, one can legitimately raise the question whether a way cannot be found from the upper curve to the lower at larger D , that is, whether in fact a two-step abstraction-recombination is what takes place. Indeed, our calculations were planned to deal with this question.

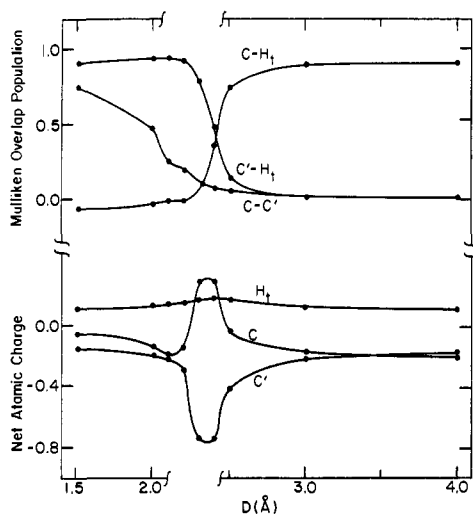

Figure 9. Overlap populations (top) and charges (bottom) along the $\text{CH}_2 + \text{CH}_4$ reaction path. The horizontal axis is broken in the region of hydrogen transfer since D here ceases to be a good reaction coordinate.

Our potential energy surface clearly indicates that the abstraction step would necessitate at least as high an activation energy as that determined for the concerted insertion. For instance, the surface cross section of Figure 1 shows a barrier of 2.5 eV between the " $\text{CH}_4 + \text{CH}_2$ " and " $\text{CH}_3 + \text{CH}_3$ " wells at $D = 4 \text{ \AA}$. At $D = 3 \text{ \AA}$ this barrier is 0.8 eV, and even at this distance the $\text{CH}_3 + \text{CH}_3$ minimum is already clearly committed to collapse to an ethane. We think it would be a rare molecular trajectory which would transfer H_t from CH_4 to CH_2 at $D > 2.5 \text{ \AA}$ and then continue to increase D to give separate methyl radicals.

It costs little in energy to move quite a distance away from either the methyl recombination or the computed insertion reaction path. This is apparent from Figures 1, 2, and 3 and was further studied by selected sweeps away from the optimized path. When it becomes possible to study molecular dynamics on this surface, this "looseness" will no doubt be reflected in high A factors for the reaction.

Further insight into the insertion reaction may be obtained by examination of the changes in electronic distribution along the reaction path. This is done in Figure 9. The steady increase in $\text{C}'\text{H}_t$ and $\text{C}-\text{C}'$ overlap populations and the corresponding decrease in $\text{C}-\text{H}_t$ is not unexpected. Note, however, that the $\text{C}-\text{C}'$ bond begins to form before H_t has moved and the remarkably correlated $\text{C}-\text{H}_t$ bond weakening and $\text{C}'-\text{H}$ bond formation. The charge distributions show that the hydrogen transfer in the transition state region is characterized by considerable negative charge accumulating on C' , the methylene carbon, balanced by positive charge at C , the methane carbon, with relatively minor charge imbalance at H_t . The buildup of electron density on the methylene is, of course, entirely consistent with its attack on methane utilizing an empty p orbital, as in 3. The interaction of this empty orbital with the $\text{C}-\text{H}_t$ σ bond results in loss of electron density at C , and its transfer to C' . Development of polarity in the transition state was suggested by Doering^{2,3} and Benson;⁶ the direction of the polarization is consistent with the selectivity exhibited by insertion on substituted $\text{C}-\text{H}$ bonds.^{2,5,17}

While our potential surface is interpreted in terms of an abstraction-like attack, it should be obvious from examination of the reaction stage illustrated in Figure 6 that the transition state is indeed a merging point of extremes 1 and 2. Finally, we note that MINDO/2 calculations of a similar potential energy surface have recently been reported.^{18,19}

Acknowledgment. Acknowledgment is made to the donors of the Petroleum Research Fund, administered by the American Chemical Society, the National Science Foundation, and the National Institutes of Health for support of this research.

(17) B. M. Herzog and R. W. Carr, Jr., *J. Phys. Chem.*, **71**, 2688 (1967).

(18) M. J. S. Dewar and collaborators, Combined Southeast-Southwest Regional Meeting of the American Chemical Society, New Orleans, La., Dec 2, 1970, Paper 603.

(19) NOTE ADDED IN PROOF. Some recent evidence arguing against an abstraction-like attack has been obtained by C. D. Gutsche, to be published.